

MEETPUNTSLANG EN TOEBEHOREN

**GSS** HYDRAULICS

HOGEDRUKSLANGEN & KOPPELINGEN



LEVERINGSPROGRAMMA

05-2011

**GSS HYDRAULICS**

HOGEDRUKSLANGEN & KOPPELINGEN

# Leveringsprogramma

**GSS Hydraulics BV**

Rokerijweg 25a, 1271 AH Huizen

Tel.: 035 - 526 53 02

Fax: 035 - 524 19 00

Email: [info@gsshydraulics.nl](mailto:info@gsshydraulics.nl)

[www.gsshydraulics.nl](http://www.gsshydraulics.nl)

Inleiding	1
Rubber slangen, Thermoplastische- en Teflon slangen	2
Slangkoppelingen 1- en 2 staalinlagen, 4- en 6 staalinlagen	3
700 Bar slangen en toebehoren	4
Adapters	5
Snijringkoppelingen, Leidingbeugels, Kogelkranen en SAE flenzen	6
Snelkoppelingen en toebehoren	7
Bonded seals en Slangbescherming	8
<b>Meetpuntslang en toebehoren</b>	<b>9</b>
Weo insteekkoppelingen	10
Diversen	11

**Inschroef-meetpuntkoppeling M16 x 2**

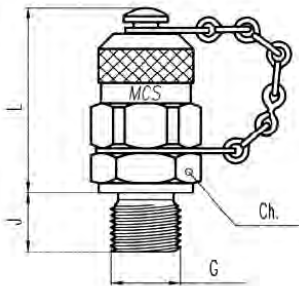

Artikelnummer	BSP	PN/WD
MA 3-R 1/8"	1/8"	400
MA 3-R 1/4"	1/4"	400
MA 3-R 3/8"	3/8"	400

Artikelnummer	Metrische draad	PN/WD bar
MA 3-M 08X1	M8x1.0	400
MA 3-M 10X1	M10x1.0	400
MA 3-M 12X1.5	M12x1.5	400
MA 3-M 14X1.5	M14x1.5	400
MA 3-M 16X1.5	M16x1.5	400

Artikelnummer	UNF draad	PN/WD
MA-3 7/16 UNF	7/16	400
MA-3 9/16 UNF	9/16	400
MA-3 3/4 UNF	3/4	400

**Tussenkoppeling met M16 x 2**

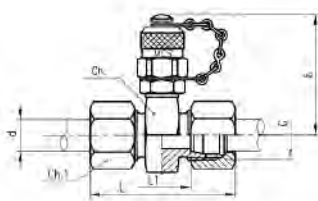

Artikelnummer	PN/WD bar	Pijpmaat mm
<b>Lichte serie</b>		
MV 3-L 06L	315	6
MV 3-L 08L	315	8
MV 3-L 10L	315	10
MV 3-L 12L	315	12
MV 3-L 15L	315	15
MV 3-L 22L	160	22
MV 3-L 28L	160	28
MV 3-L 35L	160	35
MV 3-L 42L	160	42

**Tussenkoppeling met M16 x 2**

<b>Zware serie</b>		
MV 3-L 06S	630	6
MV 3-L 08S	630	8
MV 3-L 10S	630	10
MV 3-L 12S	630	12
MV 3-L 14S	630	14
MV 3-L 16S	400	16
MV 3-L 20S	400	20
MV 3-L 25S	400	25
MV 3-L 30S	400	30
MV 3-L 38S	315	38

**Tussenkoppeling met M16 x 2**

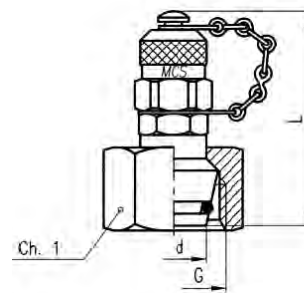

Artikelnummer	PN/WD bar	Pijpmaat mm
<b>Lichte serie</b>		
MA 3-L 06L	315	6
MA 3-L 08L	315	8
MA 3-L 10L	315	10
MA 3-L 12L	315	12
MA 3-L 15L	315	15
MA 3-L 22L	160	22
MA 3-L 28L	160	28
MA 3-L 35L	160	35
MA 3-L 42L	160	42
<b>Zware serie</b>		
MA 3-L 06S	630	6
MA 3-L 08S	630	8
MA 3-L 10S	630	10
MA 3-L 12S	630	12
MA 3-L 14S	630	14
MA 3-L 16S	400	16
MA 3-L 20S	400	20
MA 3-L 25S	400	25
MA 3-L 30S	400	30
MA 3-L 38S	315	38

### Manometerkoppeling met M16 x 2

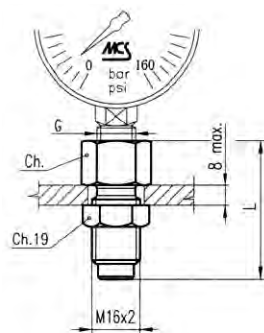

Artikelnummer	PN/WD bar	Pijpmaat mm
MAV 1/4" MA3	400	6
MAV 1/2" MA3	400	8

### Inschroef-meetpuntkoppeling met insteek

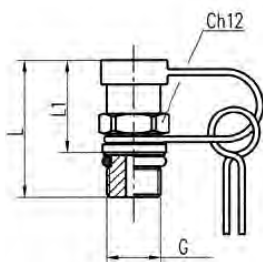

Artikelnummer	draad	PN/WD bar
MA 1/R 1/8"	1/8"	400
MA 1/M 8X1	M8x1.0	400
MA 1/M 10X1	M10x1.0	400

### Manometers

Manometers, glycerine gevuld, met RVS kast van 63 mm en een 1/4 BSP messing onderaansluiting. Voorzien van een dubbele schaalverdeling in BAR en PSI.

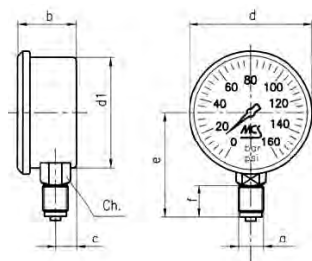

Artikelnummer	Manometer 0 t/m
	10 bar
	16 bar
	25 bar
	40 bar
	60 bar
	100 bar
	160 bar
	250 bar
	400 bar
	600 bar

De onderstaande artikelen zijn op aanvraag leverbaar

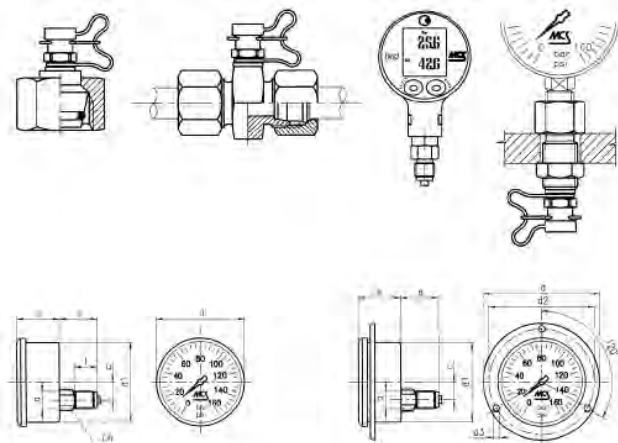

**Meetpuntslang DN02**

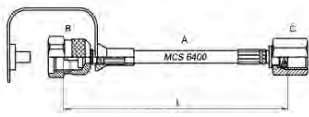

- Binnendiameter : 2mm +/- 0.1
- Buitendiameter : 5mm +/- 0.1
- Min buigradius : 20 mm
- Max werkdruk : 630 bar
- Max barstdruk : 1900 bar
- Temp. Bereik : -40 C° +100°C
- Binnenbuis : Polyamide
- Inlage : Kevlar
- Buitenmantel : Polyamide
- Gewicht : 18 g p/mtr

**Meetpuntkoppelingen**

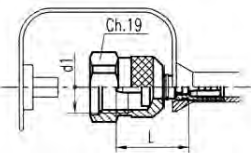

- Artikelnummer**  
 X16MP01  
 X16MP02

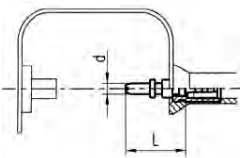

- Artikelnummer**  
 X02INS01

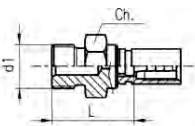

- Artikelnummer**  
 X02BM01  
 X04BM01

**Meetpuntkoppelingen**

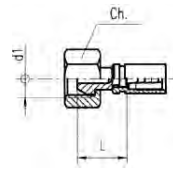

- Artikelnummer**  
 X02BF01  
 X04BF01  
 X04BF02

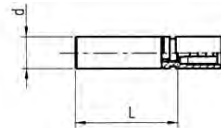

- Artikelnummer**  
 X04MOSE01  
 X06MOSE01  
 X08MOSE01  
 X04MOSE02  
 X06MOSE02  
 X08MOSE02

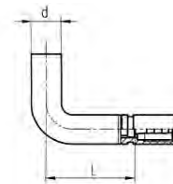

- Artikelnummer**  
 X04MOSE90501  
 X06MOSE90501  
 X08MOSE90501  
 X04MOSE90502  
 X06MOSE90502  
 X08MOSE90502

01 = tbv meetpuntslag DN02  
 02 = tbv R7+R8 DN04